

MEGA *Styro*

**PRODUCENT STYROPIANU,
STYROPAPY, STYROPIANU DACHOWEGO
I SZTUKATERI STYROPIANOWEJ**



www.megastyro.pl

PROFILE WOKÓŁOKIENNE

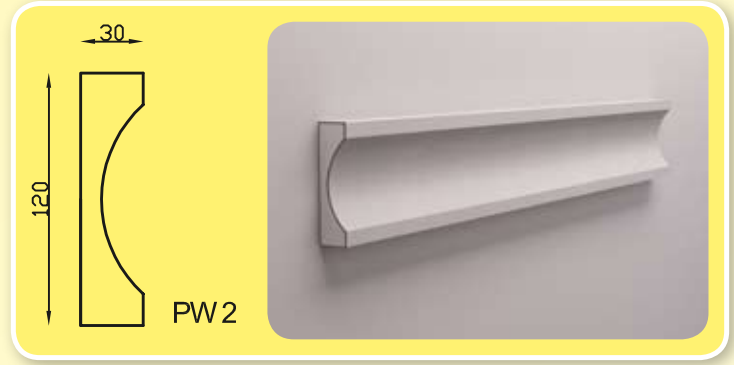

PROFILE WOKÓŁOKIENNE



PROFILE PODOKIENNE

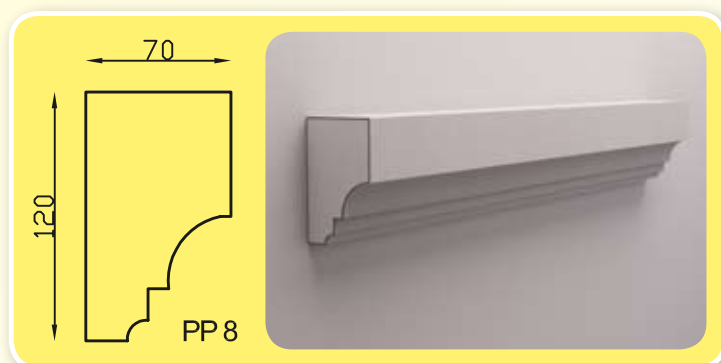
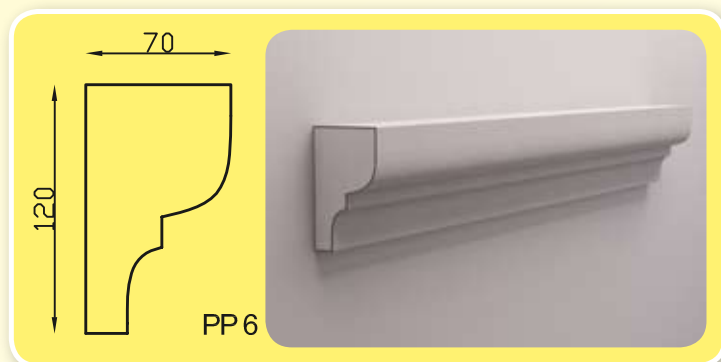
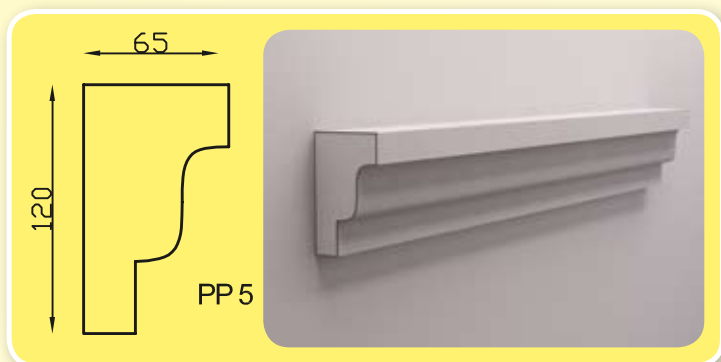
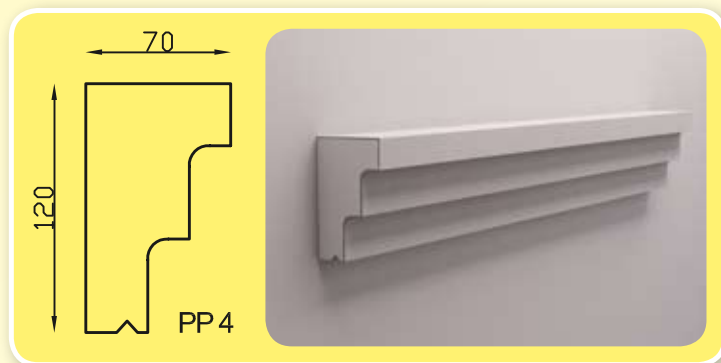
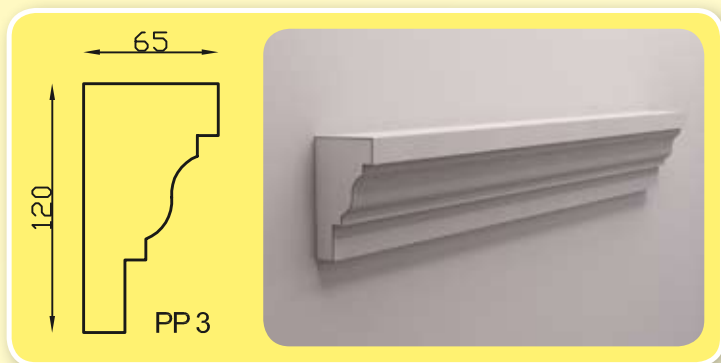
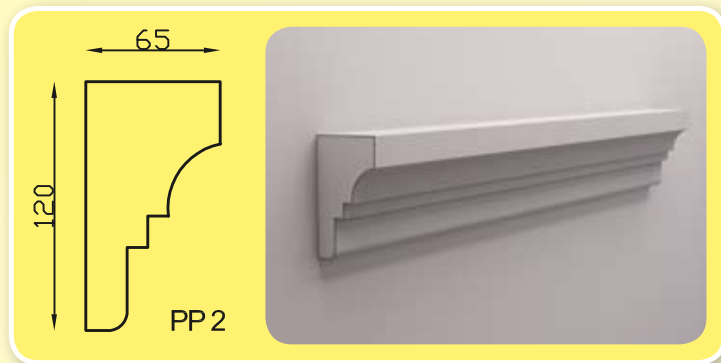
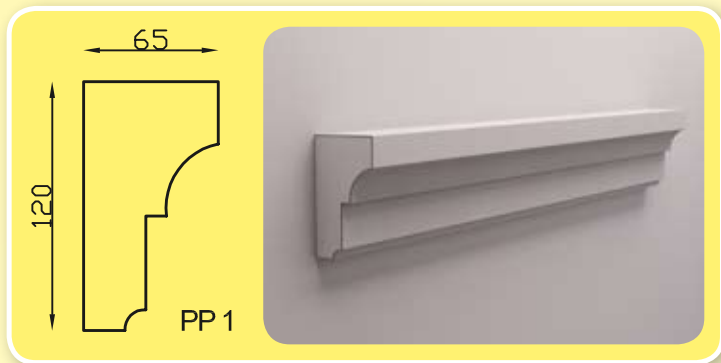

PROFILE ZEWNIĘTRZNE

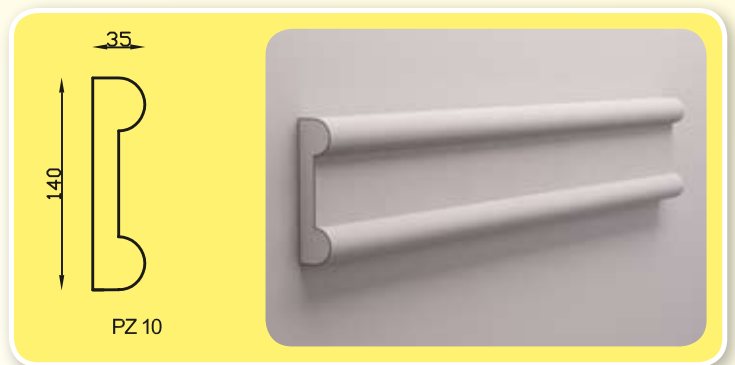
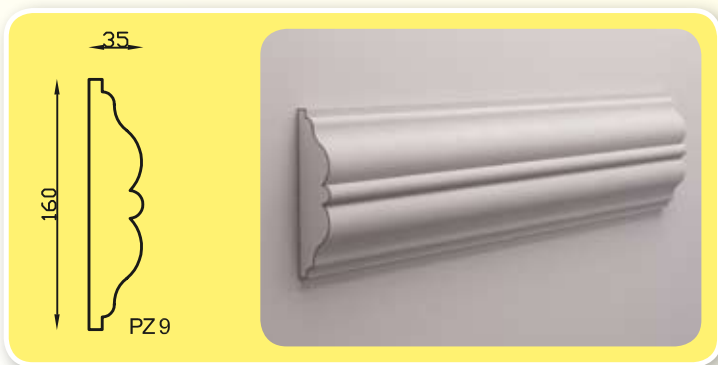
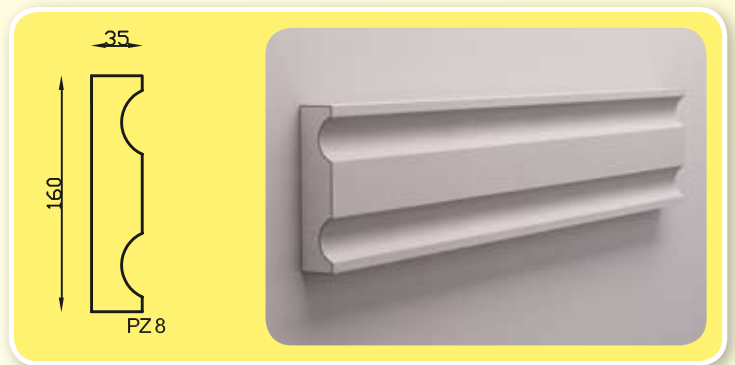
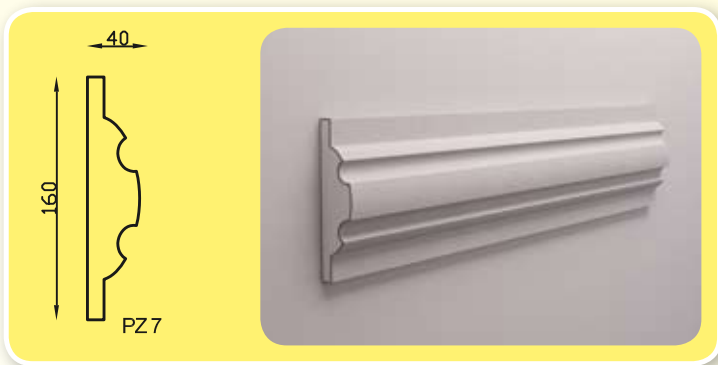
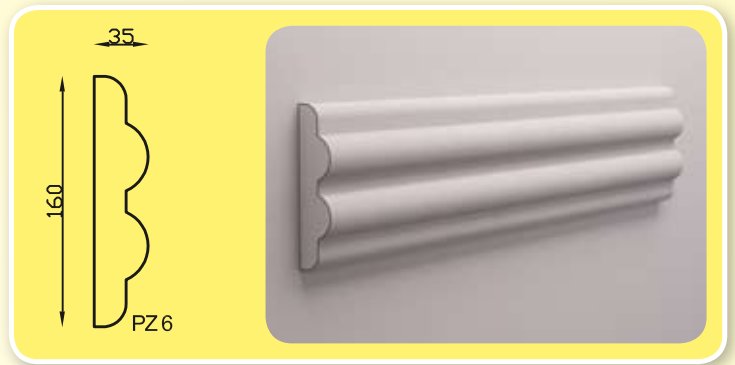
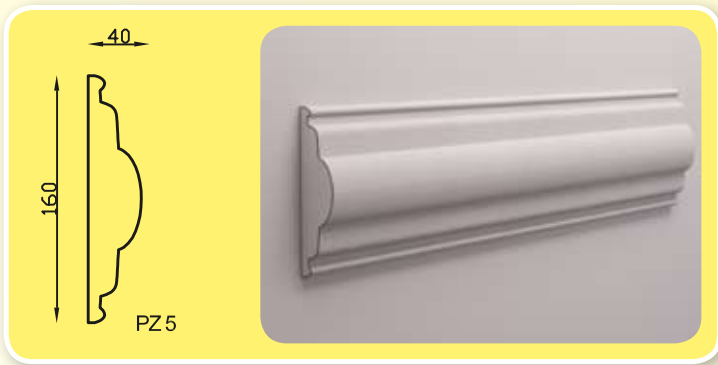
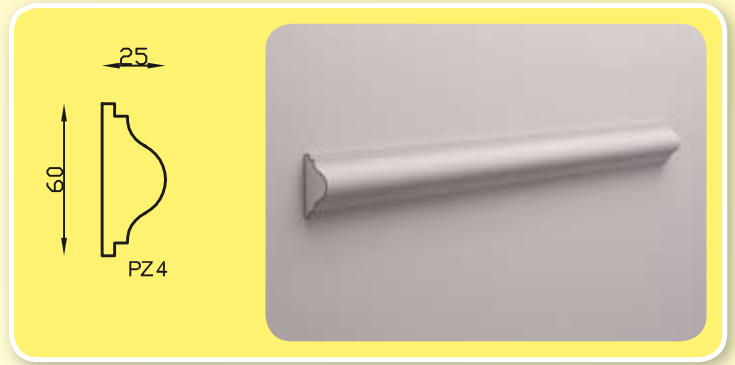
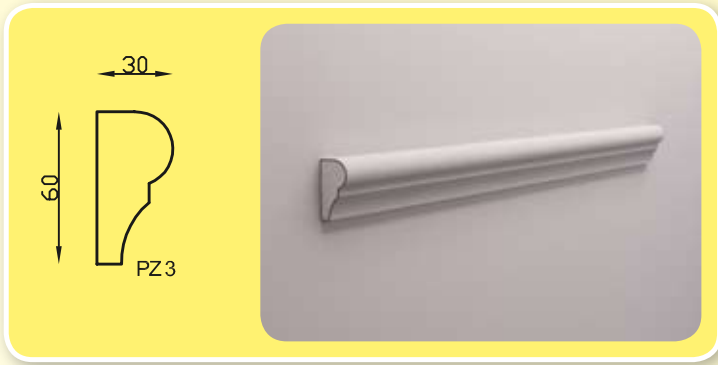
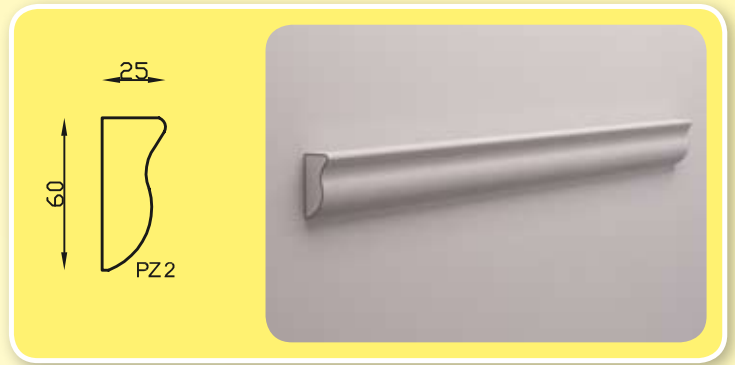

GZYMSY NADOKIENNE

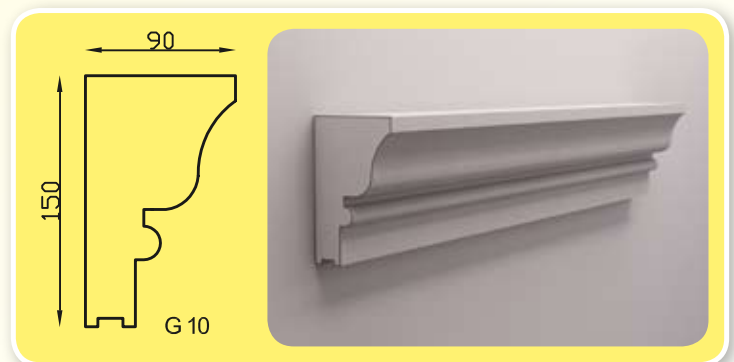
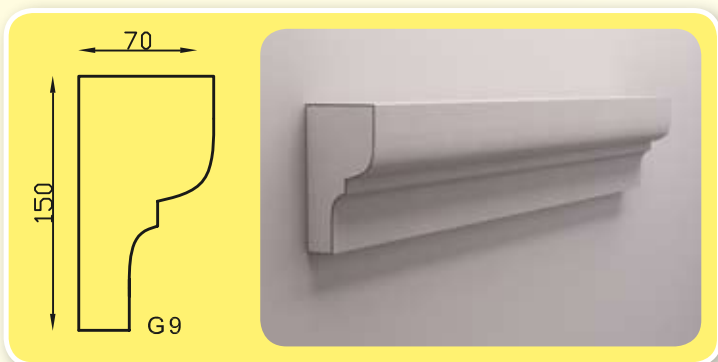
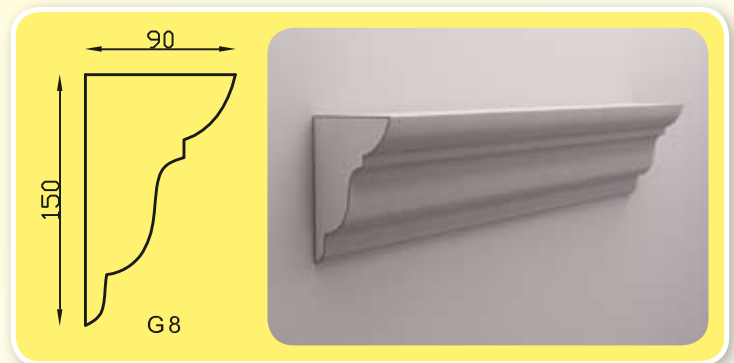
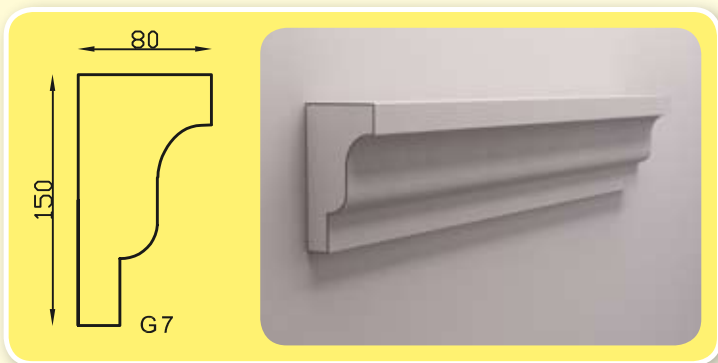
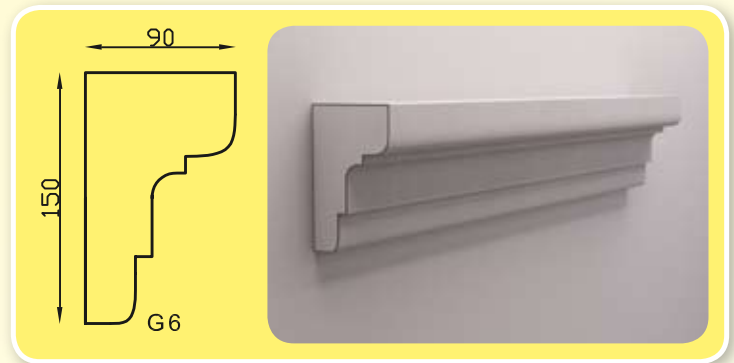
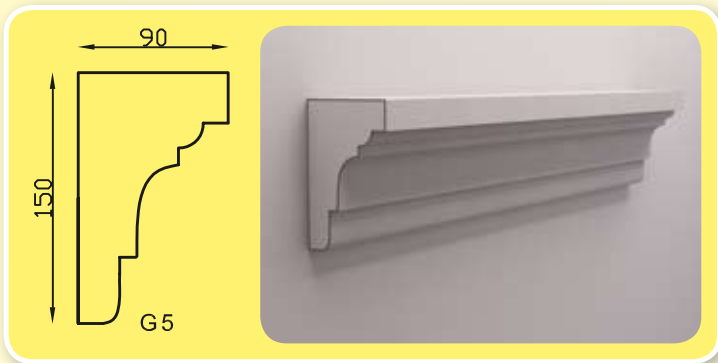
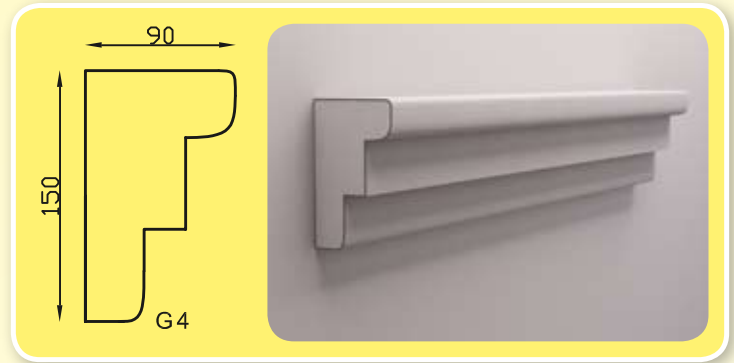
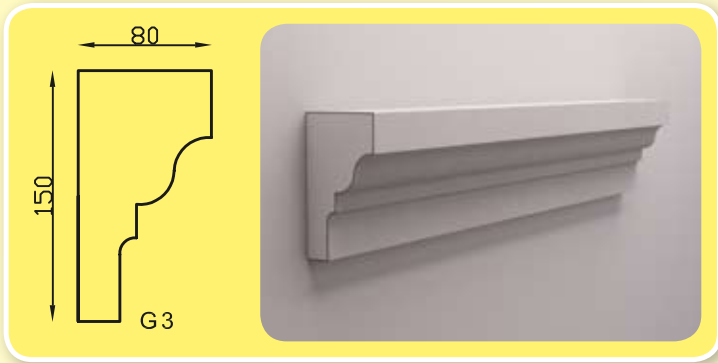
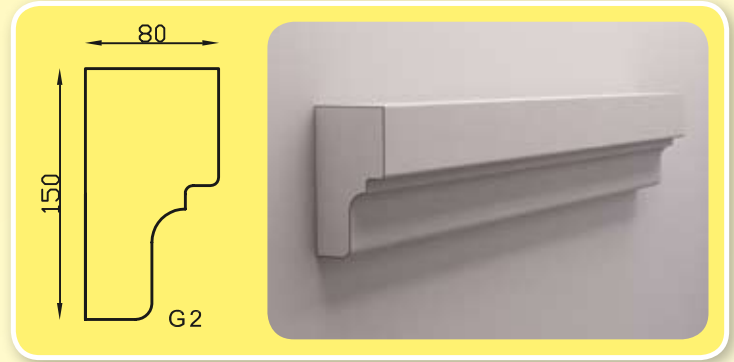
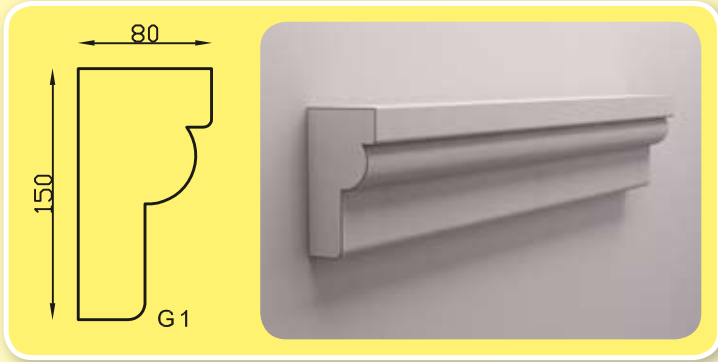

GZYMSYWIĘCZĄCE

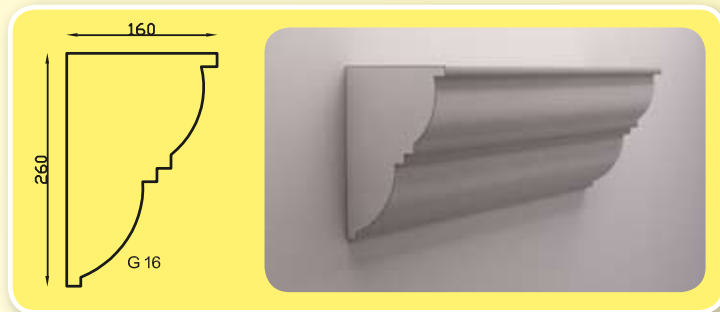
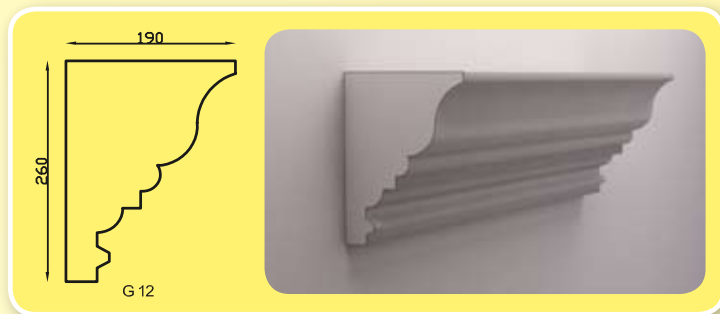
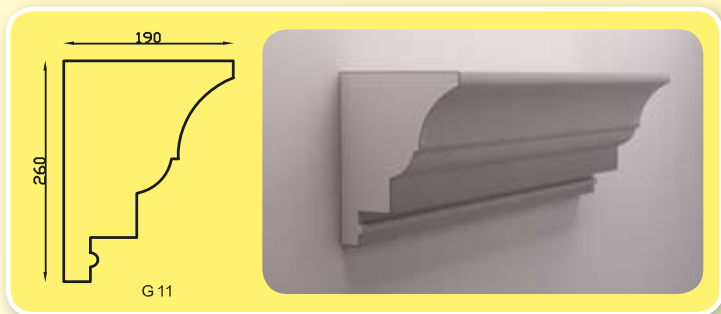

ZWORNIKI



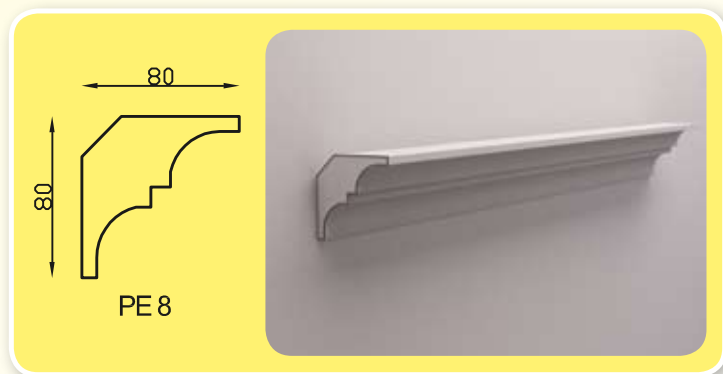
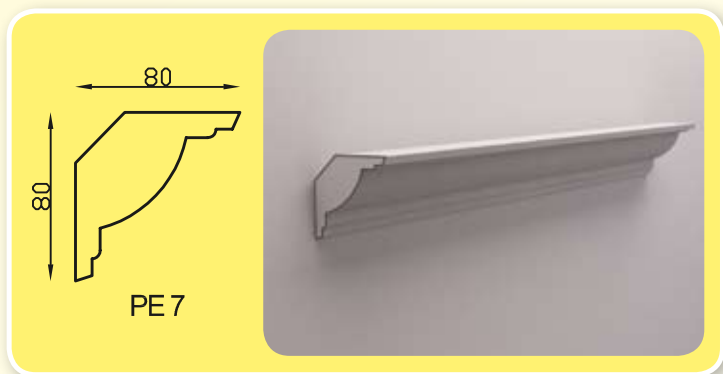
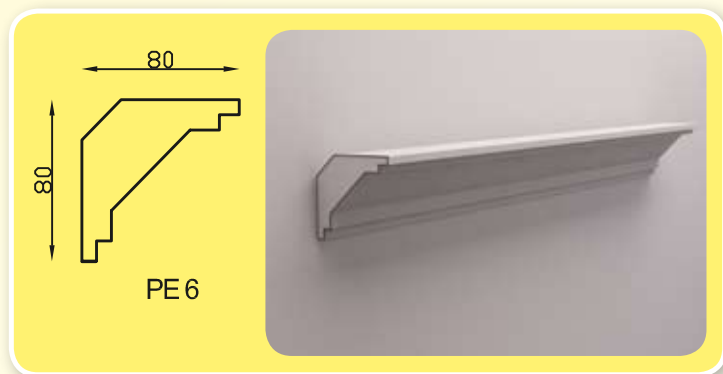
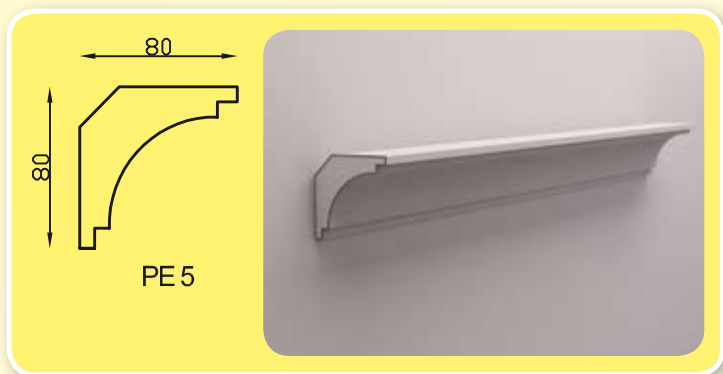
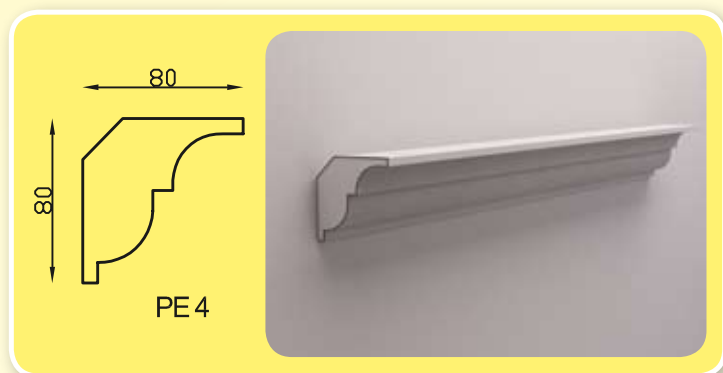
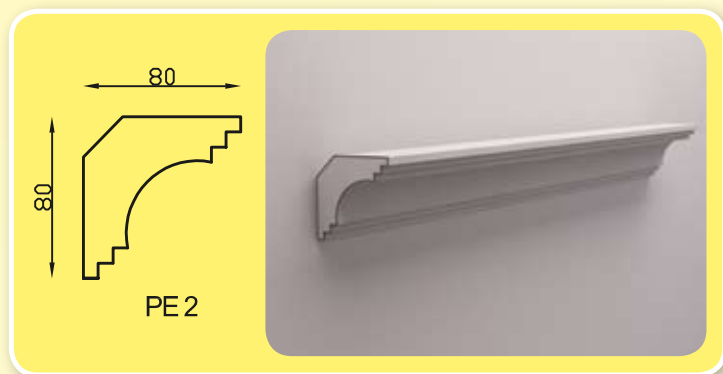
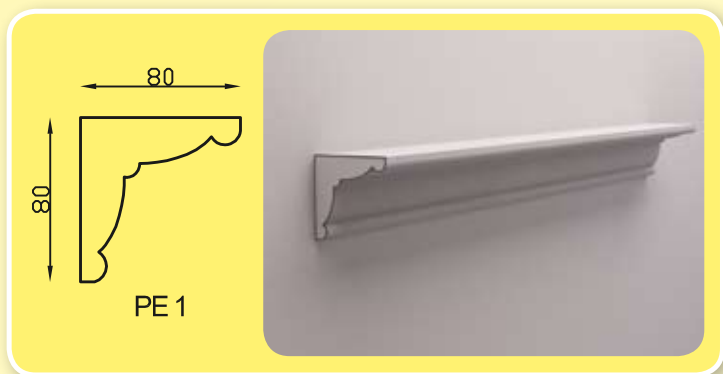

BONIE

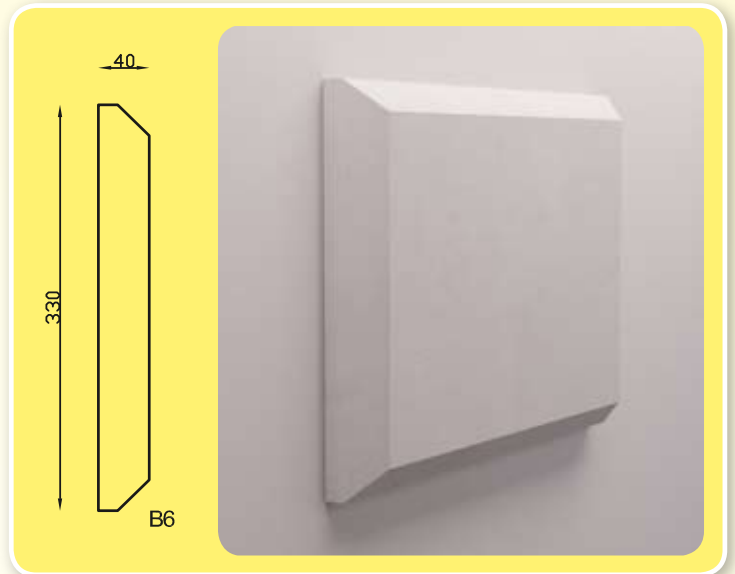
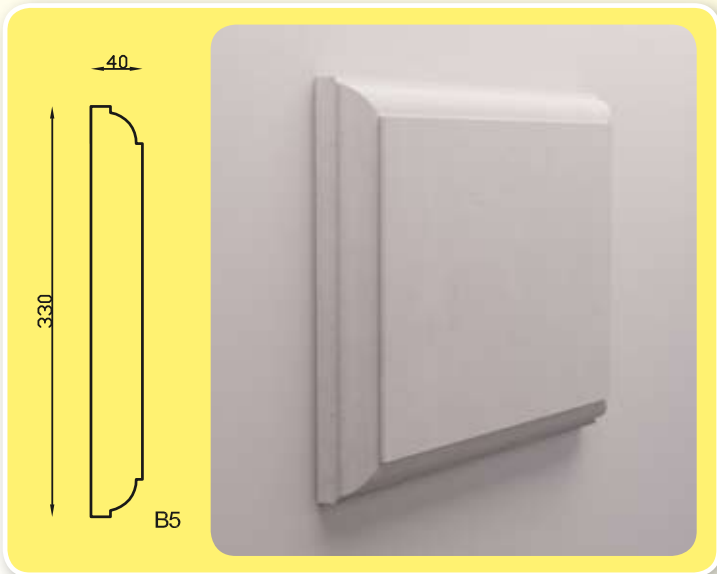
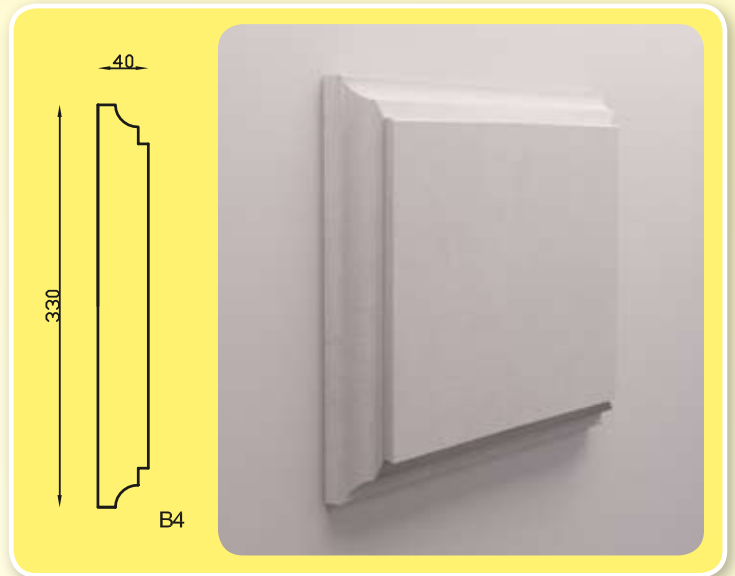
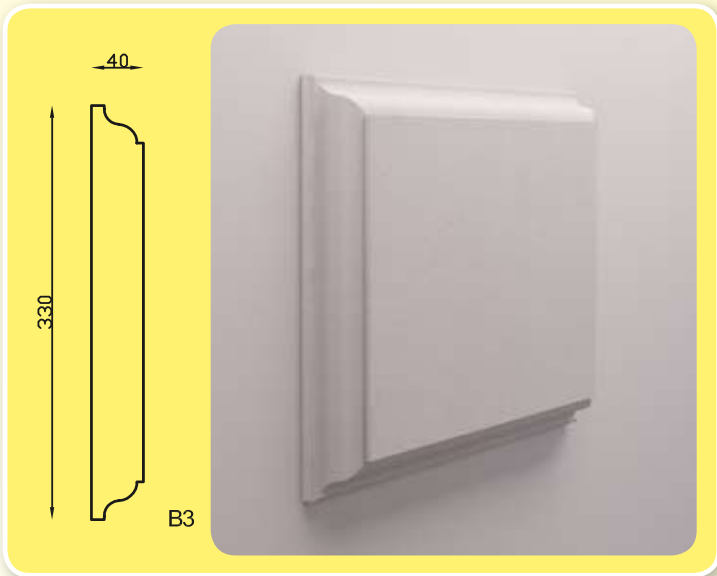
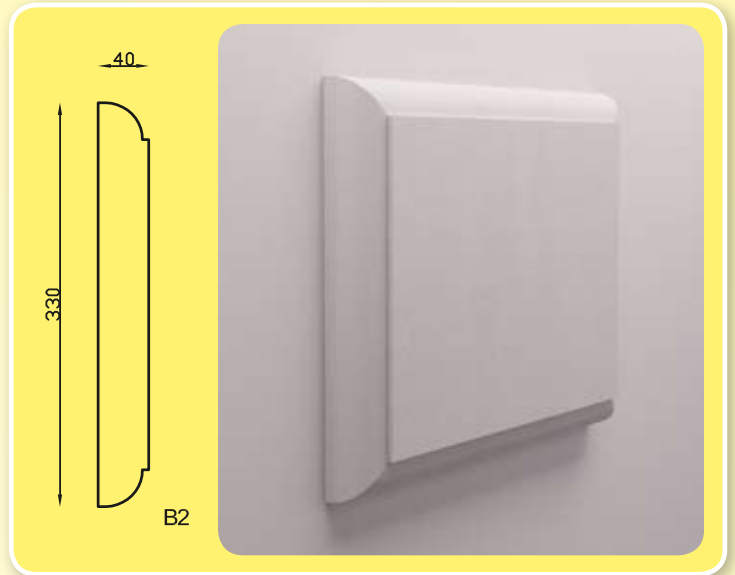
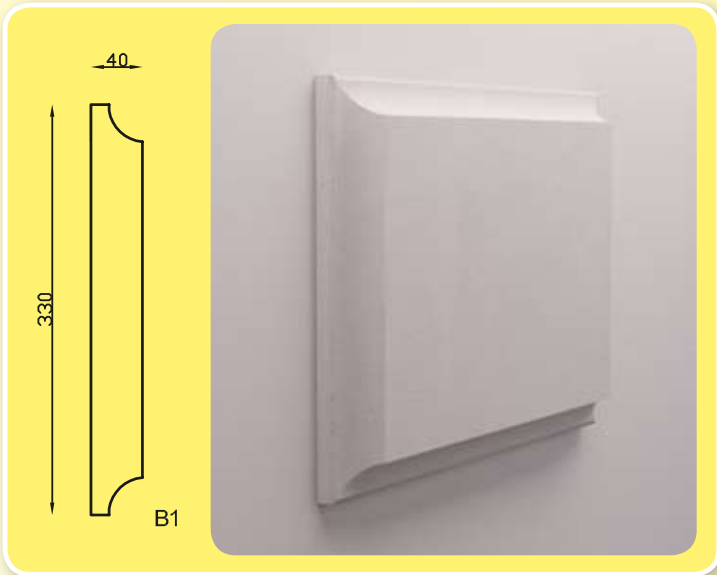

KOLUMNY

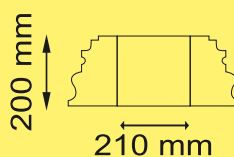
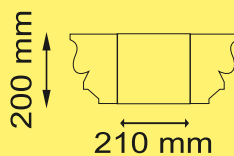
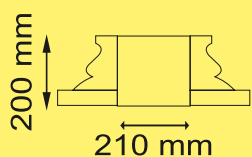
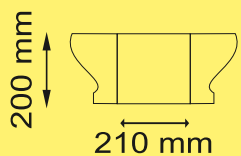
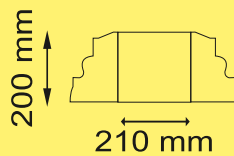
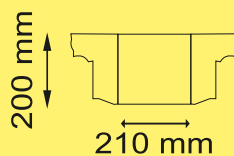
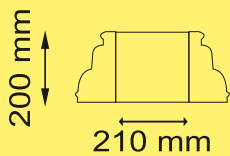
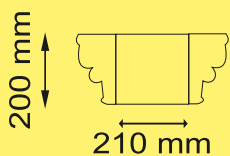
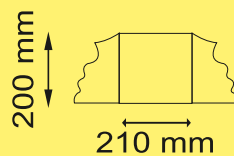
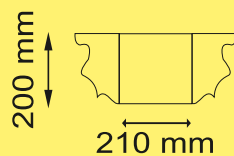
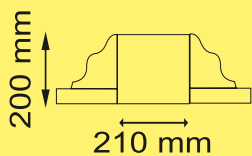
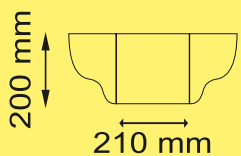

STYROPAPA

Płyty styropianowe laminowane papą podkładową jednostronnie lub dwustronnie, produkty te stosowane są do termoizolacji dachów, podłóg, tarasów, itp.

Mogą być stosowane na powierzchniach:

- betonowych
- płaskich
- z zaprawy cementowej
- blach trapezowych
- istniejących pokryciach dachowych



Standardowe wymiary płyty 1000x1000.

Na zamówienie wykonujemy płyty o dowolnej grubości.

KSZTAŁTKI DACHOWE I STYROPIAN SPADKOWY

Kształtki i kliny nielaminowane i laminowane papą podkładową, produkty te stosowane są do wykończenia dachów, kominów, itp.

Wykonujemy dowolne kształtki o wodolnych wymiarach.

OTULINY

Otuliny rur - przeznaczone do izolacji rur służących przesyłaniu cieczy, zarówno o temperaturze dodatniej, jak i ujemnej.

Otuliny na życzenie pokrywamy tynkiem polimerowym.



STYROPIAN DO OCIEPLEŃ

- Styropian EPS 70-040 - elewacja
- Styropian EPS 100-038 - dach/podłoga
- Styropian EPS 200-036 - fundament/podłoga/parking

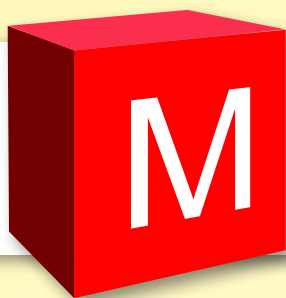

MEGA *Styro*

**PRODUCENT STYROPIANU,
STYROPAPY, STYROPIANU DACHOWEGO
I SZTUKATERII STYROPIANOWEJ**



Zakład Produkcyjny

ul. Przęsłowa 4

25-671 Kielce

tel.fax: 41 249 52 72

tel. kom.: 603 867 385, 665 485 251

e-mail: zkupis@megastyro.pl

www.megastyro.pl